



GOLDBERG BROTHERS

BARN DOOR HARDWARE

2023 EDITION

MEDIUM-DUTY BARN DOOR PRODUCTS CATALOG



MP SERIES • CP SERIES • HIDDEN ROLLER SERIES • ACCESSORIES





GOLDBERG BROTHERS

BARN DOOR HARDWARE

MEDIUM-DUTY BARN DOOR PRODUCTS CATALOG

TABLE OF CONTENTS

MP SERIES		PULL HANDLES, FLUSH PULLS, LATCHES	7
Hardware sets, roller hangers	2		
Tracks	3	CP SERIES	
Accessories	3	Overview	9
Bypass hardware	5	Hardware sets	10
		Installation reference guides	12
HIDDEN ROLLER SERIES		Warranty	16
Hardware sets	6	Color samples	inside back cover
Roller hangers	6		
Tracks	6		
Accessories	6		

Visit [GOLDBERGBROTHERS.COM](https://www.goldebergbrothers.com) for additional information and full installation instructions for most products.

Put your barn doors on the right track with the quality and convenience of Goldberg Brothers barn door hardware. Our award-winning products help make efficient use of any indoor living or working space. Our rustic, yet elegant, industrial design provides a bold focal point to any décor.

We designed our medium-duty barn door hardware product lines to offer superior style, performance, and economy when used with most medium- and light-weight interior doors. Designed to fit the most commonly used door sizes, MP Series products are a better value and outperform inferior, imported hardware. All medium-duty hardware sets are factory equipped with silent rollers, and are available in 3 or more powder coat colors. All major steel components are made with up to 90% recycled materials.

Goldberg Brothers products have been proudly made in USA since 1897. Our commitment to quality, craftsmanship and value is built into everything we do.

MP SERIES: HARDWARE SETS, ROLLER HANGERS

MP SERIES

MP J-Strap Hardware Set (complete less track)



for 1 3/8" to 1 3/4" thick doors **6008HJ-***

Set includes:

- 2 J-strap hangers with bolts and nuts
- wall mounting hardware set (6 lag bolts, spacers and washers)
- 2 track stops
- 2 anti-jump blocks with screws
- floor guide (T) with screws
- felt pads
- rubber bumper bands

MP J-Top Mount Hardware Set (complete less track)



for most common door sizes **6008HJTM-***

Set includes:

- 2 J-top mount hangers with screws
- wall mounting hardware set (6 lag bolts, spacers and washers)
- 2 track stops
- floor guide (T) with screws
- felt pads
- rubber bumper bands

MP J-Strap Hanger (1 each, with bolts and nuts)



1 1/2" x 10" x 1 1/2"

6008RJ-*

MP J-Top Mount Hanger (1 each, with screws)



3 1/2" x 4 1/2" x 1 1/2"

6008RJTM-*

MP Straight Strap Hardware Set (complete less track)



for 1 3/8" to 1 3/4" thick doors **6008H-***

Set includes:

- 2 straight strap hangers with bolts and nuts
- wall mounting hardware set (6 lag bolts, spacers and washers)
- 2 track stops
- 2 anti-jump blocks with screws
- floor guide (T) with screws
- felt pads
- rubber bumper bands

MP Top Mount Hardware Set (complete less track)



for most common door sizes **6008HTM-***

Set includes:

- 2 straight top mount hangers with screws
- wall mounting hardware set (6 lag bolts, spacers and washers)
- 2 track stops
- floor guide (T) with screws
- felt pads
- rubber bumper bands

MP Straight Strap Hanger (1 each, with bolts and nuts)



1 1/2" x 9 1/2" x 1 1/4"

6008R-*

MP Top Mount Hanger (1 each, with screws)



3 1/2" x 4" x 1 1/2"

6008RTM-*

Replace the * in the product's SKU with the code for the desired color. See inside back cover for color samples and codes.

MP SERIES: HARDWARE SETS, ROLLER HANGERS, TRACKS, ACCESSORIES

MP Horseshoe Hardware Set (complete less track)



for 1 3/8" to 1 3/4" thick doors **6008H2-***

Set includes:

- 2 horseshoe hangers with bolts and nuts
- wall mounting hardware set (6 lag bolts, spacers and washers)
- 2 track stops
- 2 anti-jump blocks with screws
- floor guide (T) with screws
- felt pads
- rubber bumper bands

MP Horseshoe Hanger (1 each, with bolts and nuts)



6" x 8 3/4" x 1 1/4"

6008R2-*

Wall Mounting Kit (set of 6 lag bolts, 6 washers, 18 spacers)



6008M-*

Track Connecting Plate (1 each)



2 3/4" x 1 1/8"

6008C-*

Track Stop (1 each, with rubber bumper band)



1 1/2" x 1 1/2" x 3/4"

6008S-*

MP Series Track



4' (for 2'0" wide door)		6008T4-*
4'8" (for 2'4" wide door)		6008T48-*
5' (for 2'6" wide door)		6008T5-*
5'4" (for 2'8" wide door)		6008T54-*
6' (for 3'0" wide door)		6008T6-*
7' (for 3'6" wide door)		6008T7-*
8' (for 4'0" wide door)		6008T8-*
bi-parting 6' (for pair of 1 1/2' wide doors)		6008T6P-*
bi-parting 8' (for pair of 2' wide doors)		6008TRP-*
Long lengths	8'1" to 10'	6008T100-*
	10'1" to 16'	6008T160-*
Custom cut service (Order a standard track length longer than what you need. We will cut it down to the correct size for you.)	1 to 5 pieces	6001CCT1
	6 to 11 pieces	6001CCT2
	12 or more pieces	6001CCT4

Soft Stop (set of 2, with triggers and screws)

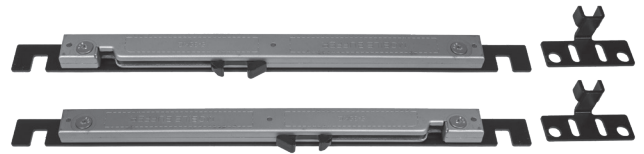

11" between center points of lag bolts (for tracks up to 7')	6008SOFT11
17" between center points of lag bolts (for tracks up to 8'+)	6008SOFT17

Hollow Core Support Plate (set of 2)



1 1/2" x 5" each

6008HCP-*

Adjustable Track Stop (1 each, with screws, nuts, and rubber pad)



5/8" x 1 1/8" x 1"

6008SC-*

MP SERIES

Replace the * in the product's SKU with the code for the desired color. See inside back cover for color samples and codes.

MP SERIES: ACCESSORIES

MP SERIES

Anti-Jump Blocks (clear acrylic, set of 2, with screws and felt pads)

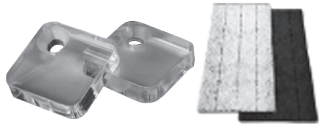

1"×1"×¼" each

6008J

Rubber Bumper Band (1 each)



1½"×½"

Black

6008833

Floor T-Guide (aluminum, 1 each, with screws)



1½"×1½"×1"

6001G-*

T-Guide, 24" Long (aluminum, 1 each, with screws)



1½"×24"×1"

6001G2-*

Adjustable U-Guide (2 pieces, with screws)



⅞"×1"×1½" each

6001U-*

All-in-One Floor Guide (1 each, with screws)



6001GA-*

Sidewall Bracket (1 each, with screws and nuts)



standard	1½"×2"×2"	6001SW-*
long	1½"×2"×2½"	6001SWE-*
extra long	1½"×2"×3¼"	6001SWEX-*

Bumper/Stay Pads (set of 4, felt strips with adhesive back)

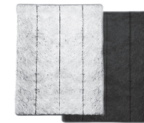

1"×⅜" each strip

White	6001BS-1
Black	6001BS-6

Hanger Stabilizer (Set of 2, with screws)



2¼"×1⅞" each

6001HS-*

Touch-up Paint (1 bottle, with brush)



0.6 fl oz

6001P-*

Replace the * in the product's SKU with the code for the desired color. See inside back cover for color samples and codes.

MP SERIES: ACCESSORIES, BYPASS HARDWARE

Pair Linking Kit

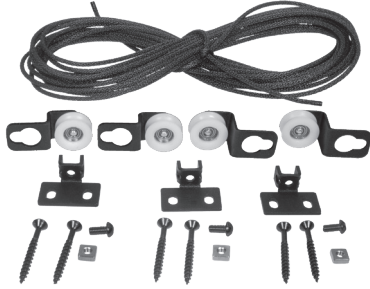

for biparting doors 36" or less	24' cord	6002PLK24-MB
for biparting doors up to 72"	50' cord	6002PLK50-MB

Replacement Cord for Pair Linking Kit



24' cord	black	6002PLC24
50' cord	black	6002PLC40

MP SERIES

Bypass Adapter Kit (set of 6 adjustable brackets, with bolts and nuts)

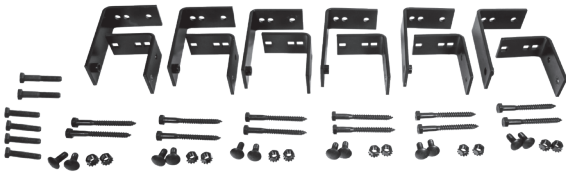

for 1 3/8" thick door with track up to 8'	6008BP3-*
for 1 3/4" thick door with track up to 8'	6008BP4-*

Bypass Single Add-On Set (1 each, with bolts, nuts, and spacer)



for 1 3/8" thick door and long track with more than 6 holes	6008BPS3-*
for 1 3/4" thick door and long track with more than 6 holes	6008BPS4-*

Bypass J-Guide and Push/Stops Kit (1 set, with screws)

(images not to scale)



for 1 3/8" thick doors	6008BPCK3-*
for 1 3/4" thick doors	6008BPCK4-*

Bypass J-Guide (1 each, with screws)



for 1 3/8" thick doors	60013GX-*
for 1 3/4" thick doors	60014GX-*

Bypass Grab/Push Stops (set of 3, with screws)



6001PSX-*

Replace the * in the product's SKU with the code for the desired color. See inside back cover for color samples and codes.

HIDDEN ROLLER SERIES: HARDWARE SETS, ROLLER HANGERS, TRACKS, ACCESSORIES

Single Roller Hardware Set (complete less track)

weight limit 125 lb



for most doors at least 1" thick

6010H1-*

Set includes:

- 2 single hidden roller hangers with screws
- wall mounting hardware set (6 lag bolts, spacers and washers)
- 2 track stops
- floor guide (T) with screws
- felt pads
- rubber bumper bands

Double Roller Hardware Set (complete less track)

weight limit 250 lb



for most doors at least 1" thick

6010H2-*

Set includes:

- 2 double hidden roller hangers with screws
- wall mounting hardware set (6 lag bolts, spacers and washers)
- 2 track stops
- floor guide (T) with screws
- felt pads
- rubber bumper bands

HIDDEN ROLLER SERIES

Single Hidden Roller Hanger (1 each, with screws)



3¼" x 3⅞" x ¾"

6010R1-*

Double Hidden Roller Hanger (1 each, with screws)



5½" x 3⅞" x ¾"

6010R2-*

Wall Mount Kit (set of 6 lag bolts, washers, and spacers)



6010M-*

Hidden Roller Series Track (same track used with MP Series)



1½" x ⅜"

4' (for 2'0" wide door)		6008T4-*
4'8" (for 2'4" wide door)		6008T48-*
5' (for 2'6" wide door)		6008T5-*
5'4" (for 2'8" wide door)		6008T54-*
6' (for 3'0" wide door)		6008T6-*
7' (for 3'6" wide door)		6008T7-*
8' (for 4'0" wide door)		6008T8-*
biparting 6' (for pair of 1½' wide doors)		6008T6P-*
biparting 8' (for pair of 2' wide doors)		6008TRP-*
Long lengths	8'1" to 10'	6008T100-*
	10'1" to 16'	6008T160-*
Custom cut service (Order a standard track length longer than what you need. We will cut it down to the correct size for you.)	1 to 5 pieces	6001CCT1
	6 to 11 pieces	6001CCT2
	12 or more pieces	6001CCT4

½" Extension Kit (set of 6 lag bolts and spacers)



6010E-*

Replace the * in the product's SKU with the code for the desired color. See inside back cover for color samples and codes.

HIDDEN ROLLER SERIES: ACCESSORIES

Track Stop (1 each)

1¼"×1½"



6010S-*

Track Connecting Plate (1 each)

2¾"×1⅞"



6008C-*

Floor T-Guide (aluminum, 1 each, with screws)

1½"×1½"×1"



6001G-*

T-Guide, 24" Long (aluminum, 1 each, with screws)

1½"×24"×1"



6001G2-*

HIDDEN ROLLER SERIES

Adjustable U-Guide (2 pieces, with screws)

7⁄8"×1"×1½" each



6001U-*

All-in-One Floor Guide (1 each, with screws)



6001GA-*

Sidewall Bracket (1 each, with screws and nuts)



standard	1½"×2"×2"	6001SW-*
long	1½"×2"×2½"	6001SWE-*
extra long	1½"×2"×3¼"	6001SWEX-*

Touch-up Paint (1 bottle, with brush)

0.6 fl oz



6001P-*

Bumper/Stay Pads (set of 4, felt strips with adhesive back)

1"×¾" each strip

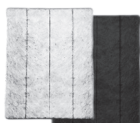

White	6001BS-1
Black	6001BS-6

Rubber Bumper Band (1 each)

1½"×½"



Black 6008833

Replace the * in the product's SKU with the code for the desired color. See inside back cover for color samples and codes.

FOR ALL BARN DOORS: PULL HANDLES, FLUSH PULLS, LATCHES

Pull Handle (1 each, with bolts, washers and nuts)

See page 10 for dimensions



12" Flush Pull (1 each, with face plate, dustbox and screws)

See page 11 for dimensions

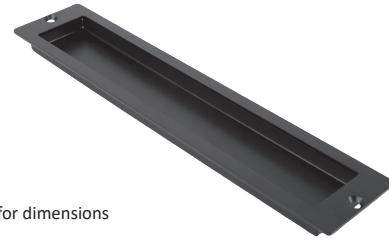

4" Pull Handle	for 1¼" - 1⅜" thick doors	6007PH304-*
	for 1½" - 1¾" thick doors	6007PH404-*
7" Pull Handle	for 1⅜" thick door	6001PH307-*
	for 1¾" thick door	6001PH407-*
	for 2¼" thick door	6001PH507-*
11" Pull Handle	Universal (fits all 3)	6001PH007-*
	for 1⅜" thick door	6001PH311-*
	for 1¾" thick door	6001PH411-*
	for 2¼" thick door	6001PH511-*
16" Pull Handle	Universal (fits all 3)	6001PH011-*
	for 1⅜" thick door	6001PH316-*
	for 1¾" thick door	6001PH416-*
	for 2¼" thick door	6001PH516-*
24" Pull Handle	Universal (fits all 3)	6001PH016-*
	for 1⅜" thick door	6001PH324-*
	for 1¾" thick door	6001PH424-*
	for 2¼" thick door	6001PH524-*
	Universal (fits all 3)	6001PH024-*

6001FP12-*

Privacy Latch (1 each, with faceplate, dustbox, strike plate and screws)

See page 10 for dimensions



6001PL-*

Biparting Privacy Latch (1 set, with screws)

See page 11 for dimensions



6001PLP-*

3" Flush Pull (1 each, with face plate, dustbox and screws)

See page 11 for dimensions



6003FP03-*

Router Templates (set of 3, clear plastic)



flush pulls and privacy latch templates

6001TMP-2

6" Flush Pull (1 each, with face plate, dustbox and screws)

See page 11 for dimensions



6001FP06-*

Replace the * in the product's SKU with the code for the desired color. See inside back cover for color samples and codes.

CP SERIES BARN DOOR HARDWARE

A RETAIL-READY BARN DOOR HARDWARE SYSTEM IN ONE BOX

CP (Consumer Pack) SERIES from Goldberg Brothers is our everything-in-one-box solution that comes ready for retail store or contractor sales. Each package starts with our MP Series J-strap hardware set for a single door or a biparting pair. Choose from 3 powder coat colors. Then select any of five pack combinations ranging from basic essentials to premium extras.

Items marked with a ✓ are included in that pack.	BASE	BASE PLUS	ADJUSTABLE	ADJUSTABLE PLUS	PREMIUM
MP J-strap hardware	✓	✓	✓	✓	✓
Standard tracks: 4', 4'8", 5', 5'4", 6', 7', 8', biparting 6', biparting 8'	✓	✓			
Extended tracks: 63", 75", 99", biparting 75", biparting 99"			✓	✓	✓
Fixed stops	✓	✓			
Adjustable stops			✓	✓	✓
J-guide	✓	✓			
All-in-one guide			✓	✓	✓
6" flush pull & 7" pull handle					✓
Soft Stops		✓		✓	✓

Contact your wholesale distributor or Goldberg Brothers sales representative for more details and available CP Series product packs.

Available in 3 popular colors:

- SILVER METALLIC
- MATTE BLACK TEXTURE
- BRONZE TEXTURE

All track, hardware and accessories are packed in one box, for convenience your customers are sure to appreciate.



MP J-Strap hardware with DuPont™ Delrin® silent rollers. (200 lb limit)



HANDLES, PULLS, LATCHES

CP SERIES

CP SERIES: HARDWARE SETS

MP J-Strap Consumer Pack Core Components (included in every CP Series configuration)



- 2× MP J-strap roller hangers with Delrin® silent rollers
- 4× hanger bolts for 1½" thick doors
- 4× hanger bolts for 1¾" thick doors
- 4× lock washers
- 4× nuts
- 6× 4½" track bolts
- 6× fender washers
- 6× 1" spacers
- 12× ½" spacers
- 2× anti-jump blocks with screws
- 2× rubber bumper bands

Base Consumer Pack (for 1 door)



with 4' track for 2' wide door	6009B4-*
with 4'8" track for 2'4" wide door	6009B48-*
with 5' track for 2'6" wide door	6009B5-*
with 5'4" track for 2'8" wide door	6009B54-*
with 6' track for 3'0" wide door	6009B6-*
with 7' track for 3'6" wide door	6009B7-*
with 8' track for 4'0" wide door	6009B8-*

Set includes:

- MP J-strap consumer pack core components for one door
- 1× MP Series flat track
- 2× fixed track stops
- 1× J-guide

2-door Base Consumer Pack (for 2 biparting doors)



with 6' biparting track for to 1'6" wide doors	6009B6P-*
with 8' biparting track for to 2'0" wide doors	6009B8P-*

Set includes:

- MP J-strap consumer pack core components for two doors
- 1× MP Series biparting flat track
- 4× fixed track stops
- 2× J-guides

CP SERIES

Base Plus Consumer Pack (for 1 door)



with 4' track for 2' wide door	6009BP4-*
with 4'8" track for 2'4" wide door	6009BP48-*
with 5' track for 2'6" wide door	6009BP5-*
with 5'4" track for 2'8" wide door	6009BP54-*
with 6' track for 3'0" wide door	6009BP6-*
with 7' track for 3'6" wide door	6009BP7-*
with 8' track for 4'0" wide door	6009BP8-*

Set includes:

- MP J-strap consumer pack core components for one door
- 1× MP Series flat track
- 2× fixed track stops
- 1× J-guide
- 2× Soft Stops

2-door Base Plus Consumer Pack (for 2 biparting doors)

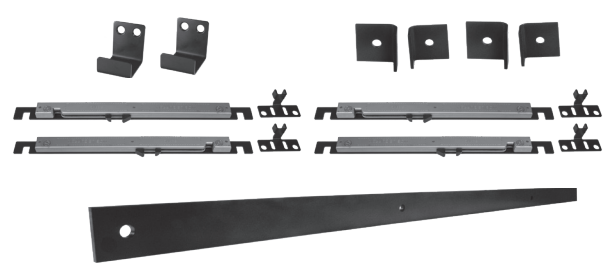

with 6' biparting track for to 1'6" wide doors	6009BP6P-*
with 8' biparting track for to 2'0" wide doors	6009BP8P-*

Set includes:

- MP J-strap consumer pack core components for two doors
- 1× MP Series biparting flat track
- 4× fixed track stops
- 2× J-guides
- 4× Soft Stops

Replace the * in the product's SKU with the code for the desired color: 1=Silver Metallic Texture, MB=Matte Black Texture, BZ=Bronze Texture. See inside back cover for color samples.

CP SERIES: HARDWARE SETS

Adjustable Consumer Pack (for 1 door)



with 63" track	6009A63-*
with 75" track	6009A75-*
with 99" track	6009A99-*

Set includes:

- MP J-strap consumer pack core components for one door
- 1x extended MP Series flat track
- 2x adjustable track stops
- 1x all-in-one guide

Adjustable Plus Consumer Pack (for 1 door)



with 63" track	6009AP63-*
with 75" track	6009AP75-*
with 99" track	6009AP99-*

Set includes:

- MP J-strap consumer pack core components for one door
- 1x MP Series flat track
- 2x fixed track stops
- 1x J-guide
- 2x Soft Stops

Premium Consumer Pack (for 1 door)



with 63" track	6009P63-*
with 75" track	6009P75-*
with 99" track	6009P99-*

Set includes:

- MP J-strap consumer pack core components for one door
- 1x MP Series flat track
- 2x fixed track stops
- 1x J-guide
- 2x Soft Stops
- 1x 7" pull handle
- 1x 6" flush pull

2-door Adjustable Consumer Pack (for 2 biparting doors)



with 75" biparting track for two doors	6009A75P-*
with 99" biparting track for two doors	6009A99P-*

Set includes:

- MP J-strap consumer pack core components for two doors
- 1x extended MP Series biparting flat track
- 4x adjustable track stops
- 2x all-in-one guides

2-door Adjustable Plus Consumer Pack (for 2 biparting doors)



with 75" biparting track for two doors	6009AP75P-*
with 99" biparting track for two doors	6009AP99P-*

Set includes:

- MP J-strap consumer pack core components for two doors
- 1x MP Series biparting flat track
- 4x fixed track stops
- 2x J-guides
- 4x Soft Stops

2-door Premium Consumer Pack (for 2 biparting doors)

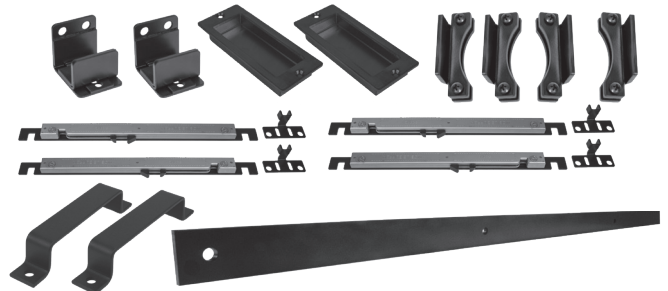

with 75" biparting track for two doors	6009P75P-*
with 99" biparting track for two doors	6009P99P-*

Set includes:



- MP J-strap consumer pack core components for two doors
- 1x MP Series biparting flat track
- 4x fixed track stops
- 2x J-guides
- 4x Soft Stops
- 2x 7" pull handles
- 2x 6" flush pulls

CP SERIES

Replace the * in the product's SKU with the code for the desired color: 1=Silver Metallic Texture, MB=Matte Black Texture, BZ=Bronze Texture. See inside back cover for color samples.

Single-Door & Biparting Pair System Layouts

These basic layouts are compatible with Goldberg Brothers Standard Series, MP/CP Series, Stainless Steel Series, and Hidden Roller Series barn door hardware. Similar layouts are also possible with Shutter Series hardware. This document provides general information. For more specific details and recommendations, see the sizing tables on the "Installation" page at GoldbergBarnTrack.com.

 T-guide location (floor mount)
 Connecting plate (track mount)
 Note: the use and position of connecting plates may vary, depending on track lengths

single door



1 barn door hardware set, 1 track = $2 \times$ the door width $-\frac{1}{2}$ "

single door wider than 4'

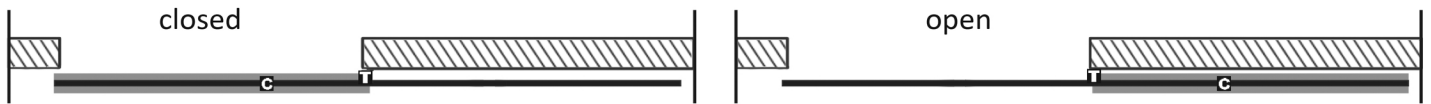

1 barn door hardware set, 1 to 3 tracks = $2 \times$ the door width $-\frac{1}{2}$ " or -1 ", track connecting plate(s), extra wall mount kit(s)

pair of biparting doors

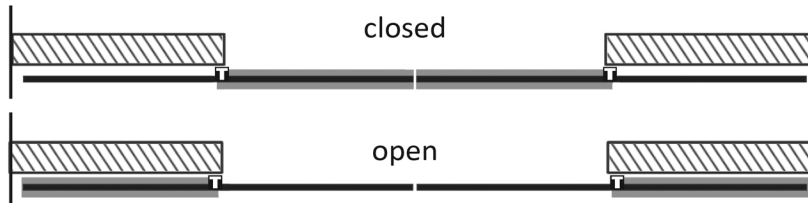

2 barn door hardware sets, 2 tracks each = $2 \times$ one door width (no connecting plate needed)

pair of biparting doors wider than 4' each

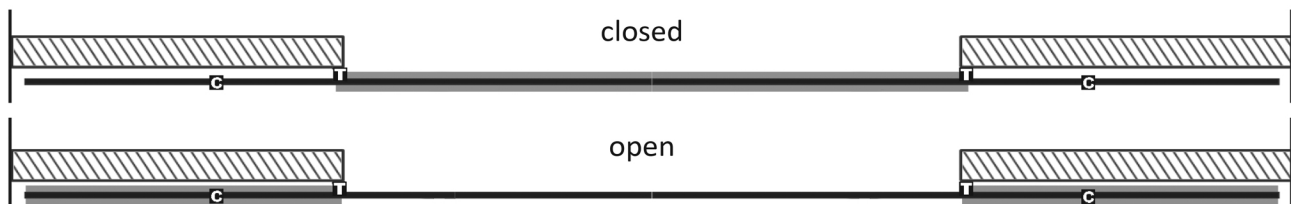



2 barn door hardware sets, 2 or 3 tracks with each pair or trio = $2 \times$ one door width $-\frac{1}{2}$ ", track connecting plate(s), extra wall mount kit(s)

INSTALLATION REFERENCE GUIDES

Bypass System Layouts

These basic layouts are compatible with Goldberg Brothers Standard Series, MP/CP Series, and Stainless Steel Series barn door hardware. Similar layouts are also possible with Shutter Series hardware. This document provides general information. For more specific details and recommendations, see the sizing tables on the "Installation" page at GoldbergBarnTrack.com.

2-door system, clear opening

-  T-guide location (floor mount)
-  J-Guide location (on back door)



1 barn door hardware set, 1 track = $2 \times$ one door width - $\frac{1}{2}$ ", 1 bypass hardware set, 1 or 2 tracks = $3 \times$ one door width - 1". Add connecting plate and wall mounting kit for third track if needed. Add bypass spacer kit(s) if needed.

4-door system, clear opening

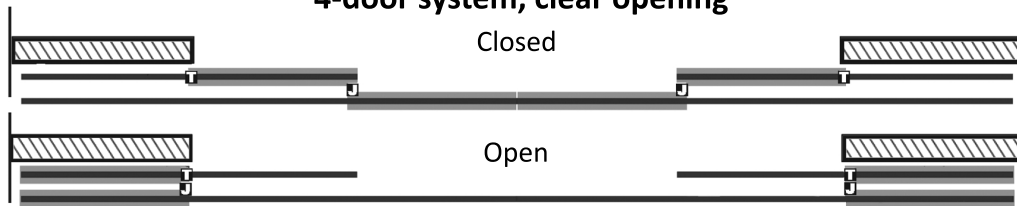

2 barn door hardware sets, 2 tracks each = $2 \times$ one door width - $\frac{1}{2}$ ", 2 bypass hardware sets, 2 or 3 tracks total = $6 \times$ one door width - 2". Add connecting plates, wall mounting kits, and bypass spacer kit(s) if needed.

2-door system, pass-through opening



1 barn door hardware set, 1 bypass hardware set, 2 tracks each = $2 \times$ one door width - 1". Add 1 extra T-guide and bypass spacer kit if needed.

4-door system, pass-through opening

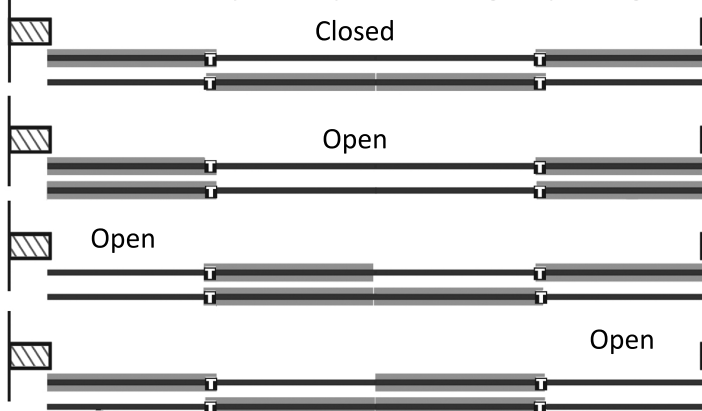

2 hardware sets, 2 bypass hardware sets, 4 tracks each = $2 \times$ one door width - 1". Add extra T-guides and bypass spacer kits if needed.

3-door system, pass-through opening

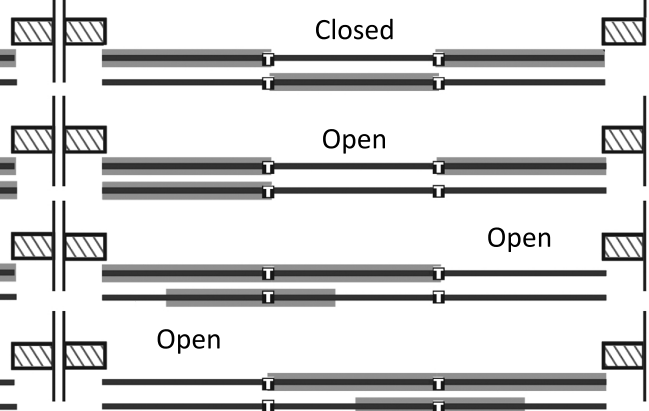

2 barn door hardware sets, 1 bypass hardware set, 2 extra T-guides, 2 tracks each = $3 \times$ one door width - 2", 2 connecting plates, 1 wall mount kit. Add 1 extra bypass spacer kit if needed.

Pull Handles

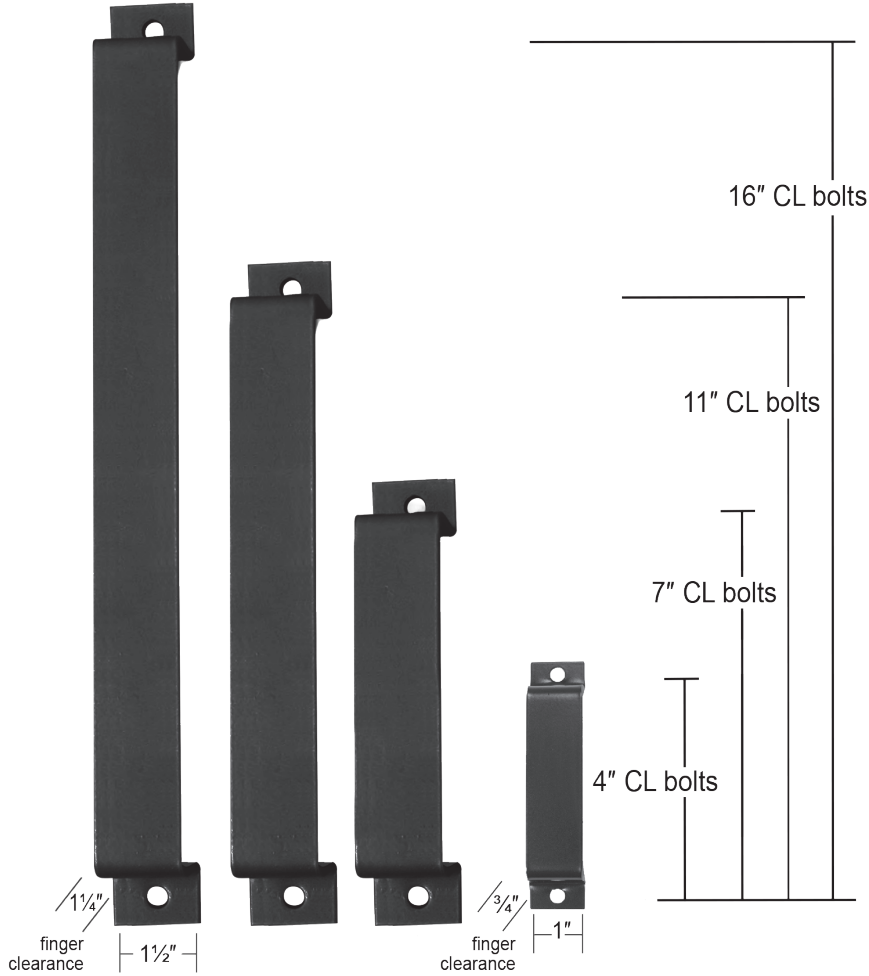

4" Pull Handle	1 1/4" to 1 3/8" 6007PH304-*		1 1/2" to 1 3/4" 6007PH404-*	
7" Pull Handle	1 3/8" 6001PH307-*	1 3/4" 6001PH407-*	2 1/4" 6001PH507-*	Universal 6001PH007-*
11" Pull Handle	1 3/8" 6001PH311-*	1 3/4" 6001PH411-*	2 1/4" 6001PH511-*	Universal 6001PH011-*
16" Pull Handle	1 3/8" 6001PH316-*	1 3/4" 6001PH416-*	2 1/4" 6001PH516-*	Universal 6001PH016-*
24" Pull Handle	1 3/8" 6001PH324-*	1 3/4" 6001PH424-*	2 1/4" 6001PH524-*	Universal 6001PH024-*

INSTALLATION
REFERENCE GUIDES

Privacy Latch

powder coated steel 6001PL-*
stainless steel 6005PL

3/16" x 1 1/4" solid bar stock

includes jamb strike & screws

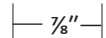
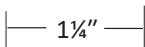
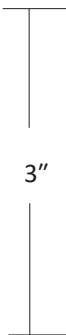
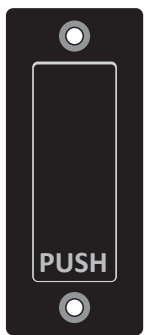

recessed box

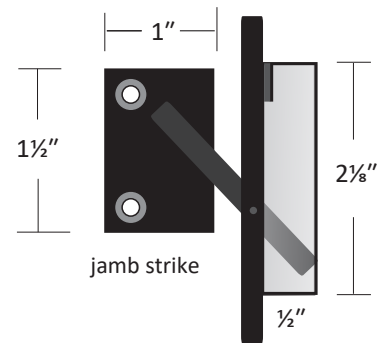

When door is on the outside of the room then the latch mounts to the door. When door is on the inside of the room then the latch mounts to the wall.

Replace the * in the product's SKU with the code for the desired color. Available in raw steel or 16 powder coat colors.

Flush Pulls

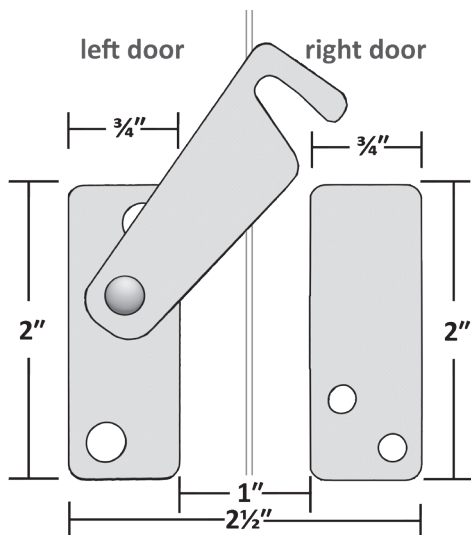
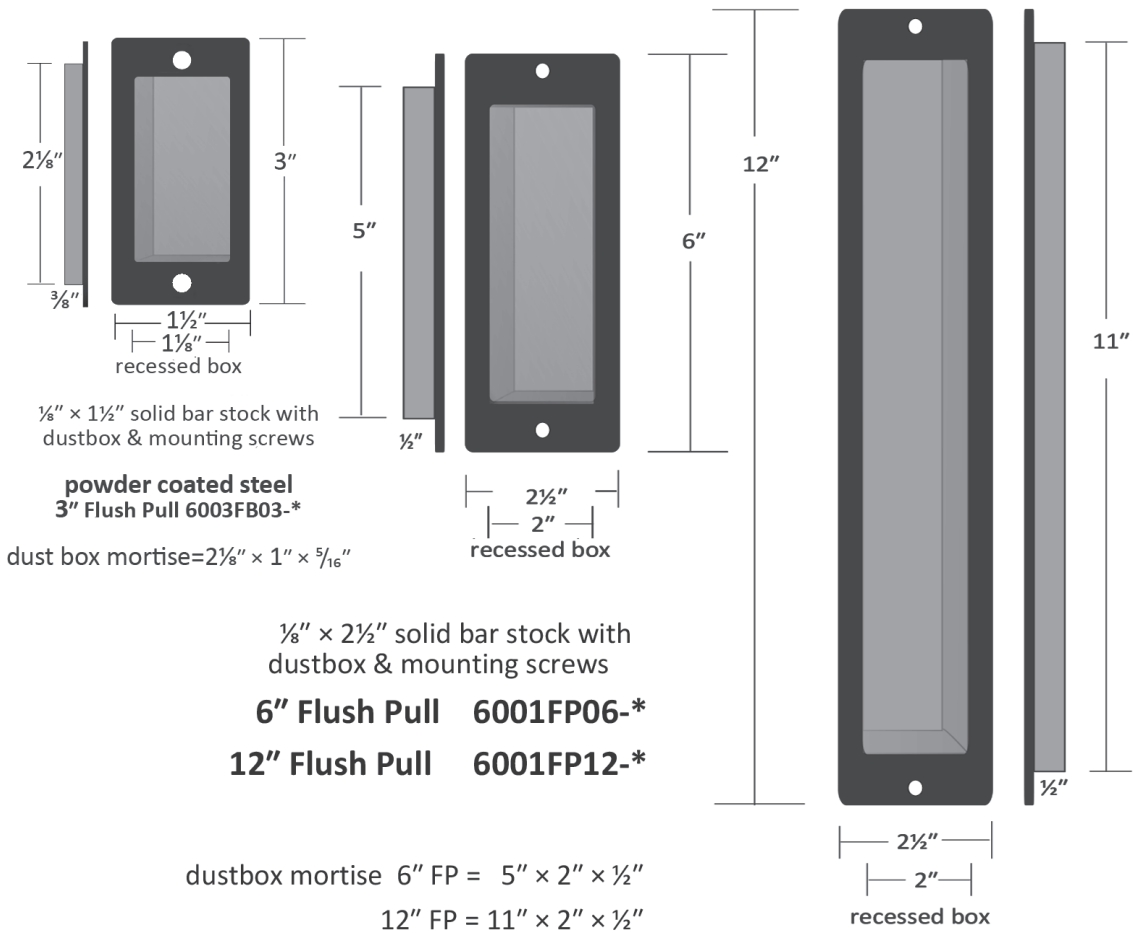

Privacy Latch for biparting doors

6001PLP-*
includes four mounting screws

Close doors and mount components with screwdriver while latch is in closed position.

Replace the * in the product's SKU with the code for the desired color. Available in raw steel or 16 powder coat colors.

WARRANTY

LIMITED LIFETIME MANUFACTURER'S WARRANTY

Goldberg Brothers warrants the functionality of its barn door hardware sets and tracks with a limited lifetime manufacturer's warranty for defective parts under normal installation and use. Warranty is subject to repair or replacement of defective components at manufacturer's discretion and does not include installation costs.

This warranty does not apply to the cosmetic condition of any products or components. Goldberg Brothers does not warrant against the loss of finish at points where the rollers are in contact with the track. Goldberg Brothers barn door hardware is sold as a rustic finished hardware and may develop scratches or other signs of wear during manufacturing or normal installation and use. Further, Goldberg Brothers does not warrant against any cosmetic imperfections in the steel parts that may be seen through the finish.

Certain accessories including but not limited to felt strips, rubber bumper bands, pair linking cords, and Soft Stop motion buffer mechanisms have finite expected lifetimes due to wear and loss of tension or resilience during normal use over an extended period. Except for manufacturing defects that become apparent within 1 year of purchase, these accessories are not covered under this limited lifetime warranty. Replacement accessories may be purchased as needed from Goldberg Brothers retailers.

Except for stainless steel components, Goldberg Brothers barn door hardware products are not warranted against rust. Some rusting is possible on any raw steel or powder coated steel hardware installed outdoors or anywhere else that it may be exposed to high humidity, rain, snow, or running water.

This warranty does not include loss or defects caused by elements outside the control of Goldberg Brothers, Inc., such as natural disasters, weather, fire, water leakage, abuse, improper installation, or anything else deemed out of the control of Goldberg Brothers, Inc.



GOLDBERG BROTHERS
BARN DOOR HARDWARE

MEDIUM-DUTY BARN DOOR PRODUCTS COLORS

Products with SKUs that end with a dash and asterisk -* are available in multiple colors.
 Replace the asterisk * with the desired color code.

COLORS OPTIONS VARY BY PRODUCT LINE:







MP Series - Black, Silver Metallic, Arch Bronze







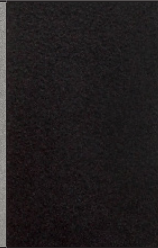

Hidden Roller Series - Black, Silver Metallic, Arch Bronze

CP Series - Silver Metallic, Black Matte Texture, Bronze Texture

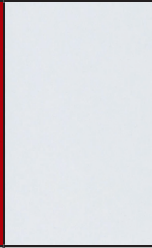
Pull Handles, Flush Pulls, Latches - raw steel and all 16 powder coat colors below

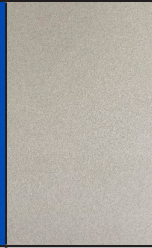
Accessories with 6001 part numbers - raw steel and all 16 powder coat colors below

ECONOMY COLORS			STANDARD COLORS			UPGRADE COLORS	
							
RAW STEEL (not coated)	MATTE BLACK TEXTURE	BRONZE TEXTURE	BLACK	SILVER METALLIC	ARCH BRONZE	RUSTIC BROWN	JACOB'S GOLD
Color code "0"	Color code "MB"	Color code "BZ"	Color code "6"	Color code "1"	Color code "8"	Color code "4"	Color code "G"

DESIGNER COLORS								
								
PC CHROME	REGAL RED	ROCKET WHITE	BLUE RIBBON	FLINT GRAY TEXTURE	DARK GRAY TEXTURE	WHITE BRONZE TEXTURE	SILVER VEIN	COPPER VEIN

Use color code "D" and write the name of the designer color on the order form.

PLEASE NOTE:

- Due to variations in printers and display screens, all color representations above are approximate. Color sample cards are available. Ask your Goldberg Brothers sales representative for details.
- Raw steel does not have a protective coating. Rusting will occur.
- PC Chrome is a powder coat finish with a glossy, chrome-like appearance. It is not chrome plating.
- Steel components used with Matte Black Texture and Bronze Texture may have minor surface blemishes acquired during the manufacturing process. These superficial variations will be hidden by the powder coating and do not affect product performance.



GOLDBERG BROTHERS, INC.

- Award-winning barn door hardware
- House and apartment number signs
- Movie-themed home decor products
- Movie theater projection ports and film reels
- Secure package delivery systems
- Custom metal fabrication

10488 W. Centennial Rd., Suite 100

Littleton, CO 80127 USA

Phone (303) 321-1099 • Fax (303) 388-0749

goldbergbrothers.com